

Bosse



SOLUTIONS.

SOLUTIONS.

Die moderne Arbeitswelt ist anspruchsvoll und vielseitig, lebhaft und variabel wie nie zuvor. Sie ist unsere Inspiration für Einrichtungslösungen, die geschaffen sind für einen Büroalltag voller Herausforderungen. Für konzentriertes Arbeiten wie für kommunikative Begegnungsräume.

Das hochwertige Einrichtungsprogramm modul space kombiniert zeitloses Bauhaus-Design mit dem einfachen Baukasten-Prinzip. Es bietet Ihnen intelligente Office-Lösungen und ganzheitliche Raumkonzepte für heute und morgen. Abgestimmt auf Ihre Bedürfnisse, variabel und modular für Veränderungen, nachhaltig für eine lange Zeit.

Erleben Sie auf den nächsten Seiten die Kombinationsvielfalt und Vorteile von modul space anhand beispielhafter Lösungen. Entdecken Sie die überlegenen Vorteile der Bosse Raum in Raumsysteme, Bosse Cube und Telefon Cube für moderne Open Space Offices.

The modern world of work is more demanding and varied, vibrant and flexible than ever before. It is our inspiration for furniture solutions geared to the challenges of day-to-day life in the office. For focused working and for places to meet and communicate.

The high-quality modul space furniture range combines timeless Bauhaus design with a simple building block principle. It offers intelligent office solutions and integrated room concepts for today and tomorrow. Tailored to your needs, variable and modular to cater for changes, built to last for a long time.

Over the next few pages, you can experience the wide range of combinations and advantages of modul space on the basis of example solutions. Discover the superior advantages of the Bosse space in room systems, the Bosse Cube and Telephone Cube for modern open-plan offices.

From Bauhaus to Bosse	3
Welcome	4 - 9
Work	10 - 15
Lead	16 - 19
Meet	20 - 21
human space Cube	22 - 23
Telefon Cube Telephone Cube	24 - 25
Vive la Couleur	26 - 29
Farben und Materialien Colours and materials	30 - 31
Das System The System	32 - 33
Referenzen References	34 - 35

FROM BAUHAUS TO BOSSE

BAUHAUS



1919

Gründung Bauhaus in Weimar. In der legendären Kunst-, Design- und Architekturschule werden die Vorläufer der industriellen Möbelfertigung entwickelt.

Bauhaus founded in Weimar. The forerunners of industrial furniture manufacture were developed in the legendary school of art, design and architecture.

ABSTRACTA



1960er

Das Stahlrohr-Knoten-System „Abstracta“ des dänischen Architekten Poul Cadovius inspiriert bis heute Designer und Architekten durch Ästhetik und hohe Funktionalität. Rohre, Knoten und Paneele sind auch die elementaren Bauteile von Bosse modul space.

The "Abstracta" steel tubing/connector system from the Danish architect Poul Cadovius still inspires today's designers and architects with its aesthetics and high functionality. Tubes, connectors and panels are also the fundamental elements of Bosse modul space.

BOSSE DESIGN



1964

Gründung Bosse Design in Hötter. Günter Bosse setzt den Schwerpunkt auf die Entwicklung innovativer Systemränne und -trennwände.

Bosse Design founded in Hötter. Günter Bosse focusses on developing innovative modular cabinets and dividing walls.

BOSSE ROOM IN ROOM SOLUTION



1980er

Bosse entwickelt die erste vom Gebäudekörper unabhängige Raum-in-Raum-Lösung. Als Pionier auf diesem Gebiet feiert Bosse besonders große Erfolge im Shop-in-Shop-Bereich.

Bosse develops the first room-in-a-room solution that works regardless of a building's shell. As a pioneer in this field, Bosse celebrates particular successes in the shop-within-a-shop area.

DAUPHIN GROUP



1992

Bosse stellt sich international auf und wird Teil der Dauphin-Gruppe. Das durchdachte Raum-in-Raum-System hält Einzug in Großunternehmen.

Bosse adopts an international profile and becomes part of the Dauphin Group. The clever room-in-a-room system becomes established in major companies.

1 IDEA.1000 POSSIBILITIES.



2002

Bosse übernimmt den Büromöbelhersteller mrd und bringt das System modul space zur Marktreife. Hauptfokus und wesentliches Gestaltungsmerkmal: die Kombination von Rohren, Knoten und Paneelen.

Bosse takes over the office furniture manufacturer mrd and brings the modul space system to market maturity. Focus on pipes, knots, panels - as an essential design feature.

DAUPHIN HOME COLLECTION



2010

Start Dauphin Home - die neue Wohnmöbelkollektion der Dauphin-Gruppe.

Start Dauphin Home - the new home collection of the Dauphin Group.

RETHINK SPACES



2012

Bosse entwickelt die neue Generation des human space Cubes und begeistert mit modernster Technik in dynamischer Formensprache.

Bosse develops the new generation of the human space Cubes and inspires with state-of-the-art technology in a dynamic form language.

COMEBACK TELEPHONE BOX



2016

Der Bosse Telefon Cube wird eingeführt - für vertrauliche Telefonate im Open Space.

The Bosse Telephone Cube is launched - for confidential phone calls in an open space.

VIVE LES COULEURS DE LE CORBUSIER



2017

Bosse präsentiert auf der imm cologne 2017 erstmalig das modul space Systemmöbel in 12 Farben von Le Corbusier: Form, Funktion und Farbe in zeitloser Vollendung. Hier zu sehen in der einmaligen Villa Savoye.

For the first time Bosse presents on the imm cologne 2017 the modul space system furniture in 12 colours of Le Corbusier. To see here at the unique Villa Savoye.

AWARDED



2017

Der deutsche Rat für Formgebung zeichnet Bosse mit dem German Brand Award für erfolgreiche Markenführung aus.

The German Design Council honor Bosse with the German Brand Award for successful branding.

LOOKING FORWARD...

Das modulare System offenbart auf den ersten Blick seine Vielfältigkeit: Variable Thekenelemente bieten individuelle Kombinationsmöglichkeiten und sind durchdacht bis ins Detail. Die hochwertigen Fronten sind in einem breiten Farb- und Materialspektrum erhältlich – so gestalten Sie den Empfangsbereich in Ihren Unternehmensfarben.

The versatility of the modular system can be seen at first glance. Variable counter units offer individual combination options and are carefully thought out down to the last detail. The high-quality fronts are available in a wide range of colours and materials, allowing you to create a reception area in your own corporate colours.



THEKE | COUNTER

inkl. Fußraumnische (Ablage überstehend), inkl. LED-Beleuchtung, Zuleitung
Oberfläche: Preisgruppe A, Melamin
Oberfläche: Preisgruppe P, Floatglas foliert (nach Oracal Farbkarte 8500)

B 279,3 | T 200,4 | H 119,2 cm MSOS-0208

incl. foot niche (protruding shelf), incl. LED lighting, lead

Surface: Price group A, melamine

Surface: Price group P, film-coated float glass (as per Oracal colour chart 8500)

W 279,3 | D 200,4 | H 119,2 cm MSOS-0208



THEKE | COUNTER

Ringsum geschlossen
Oberfläche: Preisgruppe A, Melamin

B 359,0 | T 127,95 | H 114,0 cm MSOS-0207

Enclosed all the way round

Surface: Price group A, melamine

W 359,0 | D 127,95 | H 114,0 cm MSOS-0207



THEKE | COUNTER

inkl. Fußraumnische, 4x Schub, 1x Materialschub, abschließbar
Oberfläche: Preisgruppe A, Melamin

B 242,3 | T 122,9 | H 112 cm MSOS-0203

incl. foot niche, 4x drawers, 1x stationery drawer, lockable

Surface: Price group A, melamine

W 242,3 | D 122,9 | H 112 cm MSOS-0203



THEKE | COUNTER

inkl. 3er Schub abschließbar, 2x Kabelausschleuse weiß,
Fachböden zum Versenken des Monitors, Arbeitshöhe 75,6 cm
Oberfläche: Preisgruppe A, Melamin

B 281,1 | T 88,9 | H 114 cm MSOS-0205

incl. set of 3 lockable drawers, 2x white cable outlet sockets,

shelves for lowering the monitor, working height 75,6 cm

Surface: Price group A, melamine

W 281,1 | D 88,9 | H 114 cm MSOS-0205







2 in 1 - Büroschrank mit Garderobe oder Relaxecke mit Fachbibliothek oder... Die Einsatz- und Kombinationsmöglichkeiten der cleveren Elemente des modul space Systems sind nahezu unbegrenzt. In vielen modernen Farben erhältlich, absorbieren die Stoffpaneele Schall und optimieren somit die Raumakustik.

2 in 1 - Office cupboard with a wardrobe or a corner to relax with a specialist library or... The possible ways of using and combining the clever elements of the modul space system are almost unlimited. Available in many modern colours, the fabric panels absorb noise and thus optimise the room acoustics.



HÄNGEGARDEROBE | WALL-MOUNTED WARDROBE

Oberfläche: Preisgruppe A, Melamin

B 80,2 T 43,2 H 43,2 cm	MSOS-0407
B 100,2 T 43,2 H 43,2 cm	MSOS-0408
B 158,4 T 43,2 H 43,2 cm	MSOS-0401

Surface: Price group A, melamine

W 80,2 D 43,2 H 43,2 cm	MSOS-0407
W 100,2 D 43,2 H 43,2 cm	MSOS-0408
W 158,4 D 43,2 H 43,2 cm	MSOS-0401



GARDEROBENSCHRANK | WARDROBE

2x Garderobenstange abgehängt, inkl. Fachböden hinter Tür (Melamin), abgeschotteter Bereich für z.B. Drucker etc.

Oberfläche: Preisgruppe S, Stoff Fame

Oberfläche: Preisgruppe A, Melamin (Tür und Schrankinnenraum)

B 258,1 T 220,1 H 196 cm	MSOS-0120
------------------------------	-----------

2x suspended clothes rails, incl. shelves behind door (melamine), screened-off area for example for printer etc.

Surface: Price group S, Fame fabric

Surface: Price group A, melamine (door and inside wardrobe)

W 258,1 D 220,1 H 196 cm	MSOS-0120
------------------------------	-----------



GARDEROBENSCHRANK | WARDROBE

2x Garderobenstange abgehängt, inkl. Fachböden hinter Tür

Oberfläche: Preisgruppe A, Melamin

B 258,1 T 61,7 H 196 cm	MSOS-0118
-----------------------------	-----------

Oberfläche: Preisgruppe S, Stoff Fame

Oberfläche: Preisgruppe A, Melamin (Tür und Schrankinnenraum)

B 258,1 T 61,7 H 196 cm	MSOS-0119
-----------------------------	-----------

2x suspended clothes rails, incl. shelves behind door

Surface: Price group A, melamine

W 258,1 D 61,7 H 196 cm	MSOS-0118
-----------------------------	-----------

Surface: Price group S, Fame fabric

Surface: Price group A, melamine (door and inside wardrobe)

W 258,1 D 61,7 H 196 cm	MSOS-0119
-----------------------------	-----------



LOUNGE SOFA

Dreisitzer-Sofa mit beidseitigen Armlehnen, Metallgestell verchromt, Sitz abgesteppt
Bezug Leder Preisgruppe LE

B 229 | T 77 | H 72 cm MSCO-0008

Three-seater sofa with armrests on both sides, chrome metal frame, backstitched seat
Leather upholstery Price group LE

W 229 | D 77 | H 72 cm MSCO-0008



HOCKER | STOOL

Zweisitzer-Hocker, Metallgestell verchromt, Sitz abgesteppt
Bezug Leder Preisgruppe LE

B 154 | T 77 | H 42 cm MSCO-0007

Two-seater stool, chrome metal frame, backstitched seat
Leather upholstery Price group LE

W 154 | D 77 | H 42 cm MSCO-0007



LOUNGESESSL | LOUNGE ARMCHAIR

Fauteuil mit beidseitigen Armlehnen, Metallgestell verchromt, Sitz abgesteppt
Bezug Leder Preisgruppe LE

B 79 | T 77 | H 72 cm MSCO-0001

Lounge chair with armrests on both sides, chrome metal frame, backstitched seat
Leather upholstery Price group LE

W 79 | D 77 | H 72 cm MSCO-0001

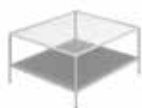

COUCHTISCH | SIDE TABLE

Oberfläche: Preisgruppe A, Melamin (unten)
Oberfläche: Preisgruppe F, Klarglas (oben)

B 81,7 | T 81,7 | H 40,2 cm MSOS-0404

Surface: Price group A, melamine (bottom)
Surface: Price group F, clear glass (top)

W 81,7 | D 81,7 | H 40,2 cm MSOS-0404



M3-DESK

Elektromotorisch höhenverstellbar, 62,5-126 cm eingestellt auf Höhe 72 cm, Kufen verchromt, Gestell weiß, schwarz, silber
Oberfläche Preisgruppe A, Melamin

B 160 | T 80 cm MSM3-1600-0800

abklappbarer Kabelkanal; weiß, schwarz, silber
B 160 cm MSKK-1600-H-02-xxxx

Kabelkette M-Desk
weiß, schwarz, silber MSKK-0000-M-61-xxxx
chrom MSKK-0000-M-61-CHRO

Electrically height-adjustable, 62,5-126 cm set to height 72 cm, chrome runners, white, black, silver frame
Surface Price group A, melamine

W 160 | D 80 cm MSM3-1600-0800

Fold-down cable duct; white, black, silver
W 160 cm MSKK-1600-H-02-xxxx

M-Desk cable chain
White, black, silver MSKK-0000-M-61-xxxx
Chrome MSKK-0000-M-61-CHRO



M-SCREEN

Anbindung: weiß, schwarz, silber

B 160 cm

MS3E-SC-1600-xxxx-LR-GRAU

M-Multifunktionschiene, Oberfläche: weiß

B 160 cm

MS3E-FS-1600-xxxx

Attachment: white, black, silver

W 160 cm

MS3E-SC-1600-xxxx-LR-GRAU

M-multifunctional rail, surface: white

W 160 cm

MS3E-FS-1600-xxxx

HIGHBOARD

mit Schiebetüren 2+1 OH, inkl. Fachböden Dekor

Oberfläche: Preisgruppe A, Melamin (Korpus)

Oberfläche: Preisgruppe B, Dekor (Front)

Oberfläche: Preisgruppe P, Floatglas foliert (1 OH Aufbau) (nach Oracal Farbkarte)

B 199,9 | T 44,7 | H 119,2 cm

MSOS-0103

With sliding doors 2+1 FH, incl. decorative shelves

Surface: Price group A, melamine (carcass)

Surface: Price group B, finish (front)

Surface: Price group P, film-coated float glass (1 FH structure) (as per Oracal colour chart)

W 199,9 | D 44,7 | H 119,2 cm

MSOS-0103





S-DESK BENCH

Systemtisch, Gestell verchromt, höhenverstellbar, Höhe (mm): 720 (680-780)
 Platte 2-geteilt, 6 Beine, mittig Screen 40 cm hoch
 Oberfläche: Preisgruppe A, Melamin
 Oberfläche: Screen: Stoff Fame beidseitig Akustik

B 180,0 | T 155,6 cm MSOS-0505

Modular table, height-adjustable chrome frame, height (mm): 720 (680-780)
 Table top in 2 parts, 6 legs, central screen 40 cm high

Surface: Price group A, melamine

Surface: Screen: Fame acoustic fabric on both sides

W 180,0 | D 155,6 cm MSOS-0505



HIGHBOARD

Sideboard mit 2 Doppeltürelementen 3 OH, mittig offenes Element mit
 2 höhenverstellbaren Fachböden

Oberfläche: Preisgruppe A, Melamin

B 238,10 | T 44,7 | H 119,20 cm MSOS-0012

Sideboard with 2 double door units 3 FH, open unit in the middle with
 2 height-adjustable shelves

Surface: Price group A, melamine

W 238,10 | D 44,7 | H 119,20 cm MSOS-0012



HIGHBOARD

Highboard mit 2 Doppeltürelementen, innen je 1 Fachboden, oben offenes
 Element mit Glas folierten Paneelen, vom Arbeitsplatz aus nutzbar.

Oberfläche: Preisgruppe A, Melamin

Oberfläche: Preisgruppe P, Floatglas foliert (nach Oracal Farbkarte)

B 159,9 | T 44,7 | H 119,2 cm MSOS-0040

Highboard with 2 double door units, each with 1 shelf inside, open unit at the
 top with film-coated glass panels, can be used from a workstation.

Surface: Price group A, melamine

Surface: Price group P, film-coated float glass (as per Oracal colour chart)

W 159,9 | D 44,7 | H 119,2 cm MSOS-0040



SCHIEBETÜRENSCHRANK | SLIDING DOOR CABINET

inkl. Fachböden

Oberfläche: Preisgruppe A, Melamin

B 159,9 T 44,7 H 80,8 cm	MSOS-0104
B 199,9 T 44,7 H 80,8 cm	MSOS-0105
B 159,9 T 44,7 H 119,2 cm	MSOS-0106
B 199,9 T 44,7 H 119,2 cm	MSOS-0107

incl. shelves

Surface: Price group A, melamine

W 159,9 D 44,7 H 80,8 cm	MSOS-0104
W 199,9 D 44,7 H 80,8 cm	MSOS-0105
W 159,9 D 44,7 H 119,2 cm	MSOS-0106
W 199,9 D 44,7 H 119,2 cm	MSOS-0107



S-DESK

Systemtisch, Gestell verchromt, höhenverstellbar, Höhe (mm): 720 (680-780)
 Oberfläche: Preisgruppe A, Melamin

B 160,0 T 80,0 cm	MSS4-1600-0800
B 180,0 T 80,0 cm	MSS4-1800-0800
B 200,0 T 100,0 cm	MSS4-2000-1000

Modular table, height-adjustable chrome frame, height (mm): 720 (680-780)
 Surface: Price group A, melamine

W 160,0 D 80,0 cm	MSS4-1600-0800
W 180,0 D 80,0 cm	MSS4-1800-0800
W 200,0 D 100,0 cm	MSS4-2000-1000



S-DESK

Systemtisch inkl. Screen, Gestell verchromt, höhenverstellbar, Höhe (mm): 720 (680-780)
 Oberfläche: Preisgruppe A, Melamin

Oberfläche Screen: Akustikstoff Fame, beidseitig	
B 180,0 T 80,0 cm	MSOS-0504

Modular table incl. screen, height-adjustable chrome frame, height (mm): 720 (680-780)
 Surface: Price group A, melamine

Surface Screen: Fame, acoustic fabric on both sides	
W 180,0 D 80,0 cm	MSOS-0504





S-DESK

Systemtisch, Gestell verchromt, höhenverstellbar, Höhe (mm): 720 (680-780)
Oberfläche: Preisgruppe C, Furnier

B 160,0 T 80,0 cm	MSS4-1600-0800-0720
B 180,0 T 80,0 cm	MSS4-1800-0800-0720
B 200,0 T 90,0 cm	MSS4-2000-0900-0720

Modular table, height-adjustable chrome frame, height (mm): 720 (680-780)
Surface: Price group C, veneer

W 160,0 D 80,0 cm	MSS4-1600-0800-0720
W 180,0 D 80,0 cm	MSS4-1800-0800-0720
W 200,0 D 90,0 cm	MSS4-2000-0900-0720



CONTAINER | STORAGE UNIT

Rollcontainer inkl. Auszugset Typ 01
Ausstattung: 3 Schubladen, 1 Materialschub, mit Schloß
Oberfläche: Preisgruppe A, Melamin

B 39,2 T 76,2 H 52,4 cm	MSCT-0392-0762-0524-Typ01
-----------------------------	---------------------------

Mehrpreis Preisgruppe E
Lack RAL Farben

Mobile storage unit incl. drawer set type 01
Features: 3 drawers, 1 stationery drawer, with lock
Surface: Price group A, melamine

W 39,2 D 76,2 H 52,4 cm	MSCT-0392-0762-0524-Typ01
-----------------------------	---------------------------

Surcharge Price group E
Painted in RAL colours



SIDEBBOARD

oben je 1 OH Klappe, unten je 1 OH Schub, 0,5 OH offen (ohne Seitenpaneele)
Mittig 2x 1 OH offen

B 201,1 T 44,7 H 100 cm	MSOS-0112
-----------------------------	-----------

Drop door at top, each 1 FH, drawer at bottom, each 1 FH, 0,5 FH open (with-
out side panels) Middle 2x 1 FH open
Surface: Price group A, melamine

W 201,1 D 44,7 H 100 cm	MSOS-0112
-----------------------------	-----------







MI-DESK

Elektromotorisch höhenverstellbar, 72-136,5 cm eingestellt auf Höhe 72 cm, Gestell verchromt

Oberfläche: Preisgruppe B, Dekor

B 180 | T 90 cm

MSM4-1800-0900

B 200 | T 100 cm

MSM4-2000-1000

Integration in Sideboard

vertikale Kabelkette (M-Desk)

Oberfläche: weiß, schwarz, silber

MSKK-0000-M-6I-xxxx

Oberfläche: chrom

MSKK-0000-M-6I-CHRO

vertikale Kabelkette inkl. Magnethalterung (M-Desk)

Oberfläche: weiß, schwarz, silber

MSKK-0000-M-8I-xxxx

Electrically height-adjustable, 72-136,5 cm set to height 72 cm, chrome frame

Surface: Price group B, finish

W 180 | D 90 cm

MSM4-1800-0900

W 200 | D 100 cm

MSM4-2000-1000

Integration in sideboard

Vertical cable chain (M-Desk)

Surface: white, black, silver

MSKK-0000-M-6I-xxxx

Surface: chrome

MSKK-0000-M-6I-CHRO

Vertical cable chain incl. magnetic holder (M-Desk)

Surface: white, black, silver

MSKK-0000-M-8I-xxxx



SIDEBOARD

Sideboard mit Flügeltüren und je 1 verstellbaren Fachboden, Mittelelement mit 3 Schubladen.

Oberfläche: Preisgruppe B, Dekore (Korpus und Türen)

Oberfläche: Preisgruppe E, RAL Farben (Front Schub)

B 298,1 | T 44,7 | H 100 cm

MSOS-0113

Sideboard with double doors and 1 adjustable shelf per compartment, middle unit with 3 drawers.

Surface: Price group B, finishes (carcass and doors)

Surface: Price group E, RAL colours (drawer front)

W 298,1 | D 44,7 | H 100 cm

MSOS-0113



LOWBOARD

inkl. Auszugsboden, 4x Kabelausschdose (3x weiß, 1x chrom) für aufgedockten MI-Desk

Oberfläche: Preisgruppe E, RAL Farben

B 180,3 | T 44,7 | H 58,4 cm

MSOS-0114

Oberfläche: Preisgruppe A, Melamin

B 180,3 | T 44,7 | H 58,4 cm

MSOS-0115

incl. pull-out shelf, 4x cable outlet socket (3x white, 1x chrome) for MI-Desk docked on

Surface: Price group E, RAL colours

W 180,3 | D 44,7 | H 58,4 cm

MSOS-0114

Surface: Price group A, melamine

W 180,3 | D 44,7 | H 58,4 cm

MSOS-0115



MONITOR HUB

Typ 02 für Flachbildschirme 43 bis 50 Zoll
inkl. Lifttechnik für versenkbaren Flatscreen (ohne Flatscreen)
Oberfläche: Preisgruppe A, Melamin

B 142,7 | T 44,7 | H 100,0 cm MSOS-0108

Type 02 for 43 to 50 inch flat screens
incl. lifting technology for retractable flat screen (flat screen not included)
Surface: Price group A, melamine

W 142,7 | D 44,7 | H 100,0 cm MSOS-0108



MONITOR MEGA-HUB

inkl. Touchscreen 84" Typ 4 (inkl. Touchscreen)
inkl. Lifttechnik für versenkbaren Flatscreen
Oberfläche: Preisgruppe A, Melamin

B 212,3 | T 57,9 | H 138,4 cm MSOS-0110

incl. 84" touch screen type 4 (incl. touch screen)
incl. lifting technology for retractable flat screen
Surface: Price group A, melamine

W 212,3 | D 57,9 | H 138,4 cm MSOS-0110



MONITOR MEGA-HUB

inkl. Touchscreen 84" inkl. Anbau, Typ 4 (inkl. Touchscreen) inkl. Lifttechnik
für versenkbaren Flatscreen, mit Anbau links und rechts, inkl. Fachböden
Oberfläche: Preisgruppe A, Melamin (Korpus)
Oberfläche: Preisgruppe E, RAL Farben (Türen)

B 327,2 | T 57,9 | H 138,4 cm MSOS-0109

incl. 84" touch screen incl. attachment, type 4 (incl. touch screen) incl. lifting
technology for retractable flat screen, with attachment on left and right,
incl. shelves

Surface: Price group A, melamine (carcass)

Surface: Price group E, RAL colours (doors)

W 327,2 | D 57,9 | H 138,4 cm MSOS-0109



MS-CONFERENCE

Konferenztisch mit drei Beinen, ohne Elektrifizierung
Oberfläche: Preisgruppe A, Melamin (Gestell)
Oberfläche: Preisgruppe B, Dekor (Tischplatte)

B 350,4 | T 120,0 | H 74,0 cm MSOS-0507

Conference table with three legs, no electrification

Surface: Price group A, melamine (frame)

Surface: Price group B, finish (table top)

W 350,4 | D 120,0 | H 74,0 cm MSOS-0507





Mit dem human space Cube lassen sich Räume frei vom Gebäudekörper realisieren. Die funktionale Raum-in-Raum-Lösung in Systembauweise bietet höchste Raumqualität durch optimale Akustik mittels Absorption und Isolation, arbeitsstättenkonforme Beleuchtung und vor allem ein perfektes Belüftungssystem. Für ein kreatives, zukunftsweisendes und effizientes Arbeiten. Made in Germany.

The human space cube allows rooms to be created independently of the building shell. The functional, modular room-in-room solution ensures maximum room quality – with absorption and insulation for optimum acoustics, lighting which complies with workstation requirements and, above all, an ideal ventilation system. For creative, futuristic and efficient working. Made in Germany.





RAUM-IN-RAUM-LÖSUNG MIT INDIVIDUELLEN GESTALTUNGSMÖGLICHKEITEN

ROOM-IN-ROOM SOLUTION WITH INDIVIDUAL DESIGN OPTIONS

Vielfältige Ausstattungsmerkmale. Paneelvariationen aus Glas-, Melamin- und Akustikpaneel. Doppelverglasung, 5 mm Sicherheitsglas, optional: Sichtschutzfolierung. 24 unterschiedliche Stofffarben (Polo). Individueller Motivdruck. Reduzierte Formensprache bis ins Detail.

Wide range of equipment options. Choice of glass, melamine and acoustic panels. Double glazing, 5 mm safety glass, optional: privacy film covering. 24 different fabric colours (Polo). Individual printed motifs. Understated design down to the smallest detail.



CUBE 1



MINIMALER EINGRIFF, MAXIMALE REVERSIBILITÄT

MINIMAL EFFORT, MAXIMUM REVERSIBILITY

Schneller Um- und Abbau möglich. (z. B. Standard-Cube 3192 x 3192 mm: ca. 6 Std. à 2 Personen exklusive Transport)

Montage durch ausgebildetes Bosse-Fachpersonal.

Can be altered and dismantled quickly. (E.g. standard cube 3192 x 3192 mm: approx. 6 hours for 2 people excluding transport)

Installation by trained Bosse personnel.



OPTIMALES RAUMKLIMA

OPTIMUM ROOM CONDITIONS

Gebäudeunabhängige, geräuscharme und energieeffiziente Be- und Entlüftung (Patent-Nr. 10 2014 204 432.4): Zu- und Abluft erfolgt über eine zentrale Lüfterunit in der Decke. Belüftungssystem stufenlos einstellbar von 0-750 m³/Std. Low-noise and energy-efficient ventilation and extraction system that is independent of the building (patent No. 10 2014 204 432.4): air is supplied and extracted via a central ventilation unit in the ceiling. Infinitely adjustable ventilation system from 0-750 m³/hr.



UNGESTÖRTE KOMMUNIKATION

HÖCHSTE KONZENTRATION

UNDISTURBED COMMUNICATION

MAXIMUM CONCENTRATION

Absorberklasse A (Akustikpaneele). Schallsisolationswert von bis zu 38 dB (Messwert bezieht sich auf kompletten Cube).

A rating for sound absorbency (acoustic panels). Sound insulation value of up to 38 dB (measurement relates to complete cube).

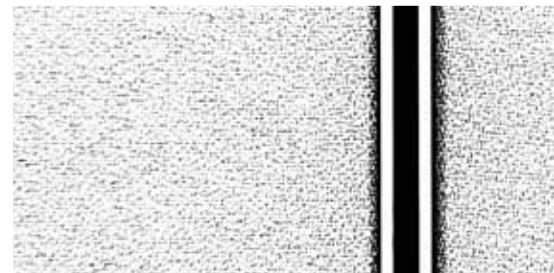

INTUITIVE BEDIENUNG

INTUITIVE OPERATION

Plug & Play: Nur ein 230 V Stromanschluss notwendig. Steuerbox-Ausführung in IP 56 (spritzwassergeschützt). Zentrale Steuerung von Licht und Belüftung durch Drehschalter im Türrahmen.

Optional: NETBOX in verschiedenen Ausführungen; Anbringung von Präsentationsmedien, z. B. Flat-TV o. Whiteboards.

Plug & play: Only a 230 V power supply is needed. IP 56 control box design (splashproof). Light and ventilation controlled centrally by rotary dials in the door frame.

Optional: NETBOX in various designs; installation of presentation equipment, e.g. flat TV or whiteboards.



NUTZUNGSGERECHTE BELEUCHTUNG

PRACTICAL LIGHTING

Bosse-Nimbus LED-Beleuchtungssystem: Stufenlos dimmbar (500 Lux – gemäß Arbeitsstättenbeleuchtung DIN EN 12464-1).

Bosse Nimbus LED lighting system: infinitely dimmable (500 lux – in accordance with DIN EN 12464-1 workplace lighting requirements).



TOP PRODUKT

TOP PRODUCT



Der Telefon Cube ist die platzsparende Lösung für vertrauliche Telefonate in der offenen Bürolandschaft. Der integrierte Präsenzmelder sorgt für die energieeffiziente Steuerung von Beleuchtung und Belüftung und ist für Büros mit einer Raumhöhe ab 2,55 Metern geeignet. Die Telefonzelle der neuen Generation.

The Telephone Cube is the space-saving solution for confidential phone calls in open-plan offices. The integrated presence detector ensures that lighting and ventilation are controlled in an energy-efficient way and is suitable for offices with a room height of 2.55 metres or more. The new generation of the telephone booth.







LIVING IN STYLE

Qualität trifft Stil – Die Verbindung des zeitlosen Chromrohrsystems mit edlen Glas-, Lack- und Naturholzoberflächen ergibt eine ganz individuelle Note.

Quality meets style – The combination of the timeless chrome tubing system with elegant glass, lacquer and natural wood surfaces produces a very individual touch.

VIVE LA COULEUR

BOSSE MEETS LE CORBUSIER

Die von Le Corbusier so überragend gestaltete Klarheit und zeitlose Moderne spiegeln sich auch im Designkonzept unseres Tragrohrmöbelsystems Bosse modul space wieder. Seit über 50 Jahren verbinden wir Form und Funktion in Perfektion und durchaus inspiriert von den Theorien Le Corbusiers. Deshalb freuen wir uns um so mehr, Ihnen unsere zeitlos eleganten Möbel in 12 ausgesuchten Farben von Les Couleurs® Le Corbusier anbieten zu können. Form, Funktion und Farbe in zeitloser Vollendung.

The clarity and timeless modernity so superbly crafted by Le Corbusier are also reflected in the design concept of our Bosse modul space tubular furniture system. For more than 50 years we have been combining form and function – with perfection and very much inspired by the theories of Le Corbusier. This is why we are so delighted to be able to offer you our timelessly elegant furniture in 12 selected colours from the Les Couleurs® Le Corbusier range. Form, function and colour in timeless perfection.



Les Couleurs®

Le Corbusier



SIDEBOARD

4x Schub

Oberfläche: Preisgruppe A, Melamine (Korpus)

Oberfläche: Preisgruppe Preisgruppe LC, Le Corbusier (Front)

B 101,7 | T 44,7 | H 100 cm

MSOS-0116

4x drawers

Surface: Price group A, melamine (carcass)

Surface: Price group Price group LC, Le Corbusier (front)

W 101,7 | D 44,7 | H 100 cm

MSOS-0116



SIDEBOARD

2x 1 OH Hängeregister, 1x 1 OH Schub, 1x 1 OH Klappe,
4x 0,5OH Schub

Oberfläche: Preisgruppe LC, Le Corbusier

B 286,3 | T 44,7 | H 80,8 cm MSOS-0117

2x 1 FH filing frames, 1x 1 FH drawer, 1x 1 FH drop door,
4x 0,5 FH drawer

Surface: Price group LC, Le Corbusier

W 286,3 | D 44,7 | H 80,8 cm MSOS-0117



Les Couleurs®
Le Corbusier

ROLLCONTAINER | MOBILE STORAGE UNIT

Auszugset Typ 05, 1 Schublade mit Hangerahmen, 1 Materialschub, mit Schlo
Oberflache: Preisgruppe LC, Le Corbusier

B 39,2 | T 56,2 | H 39,2 cm MSCT-0392-0562-0392-Typ05

Sitzkissen, Oberflache: Stofffarbe: Leder

T 56,2 cm MSCK-0392-0562-0130

Drawer set type 05, 1 drawer with filing frame, 1 stationery drawer, with lock
Surface: Price group LC, Le Corbusier

W 39,2 | D 56,2 | H 39,2 cm MSCT-0392-0562-0392-Typ05

Seat cushion, surface: fabric colour: leather

D 56,2 cm MSCK-0392-0562-0130

Auszugset Typ 01, Ausstattung: 3 Schubladen, 1 Materialschub, mit Schlo
Oberflache: Preisgruppe LC, Le Corbusier

B 39,2 | T 56,2 | H 52,4 cm MSCT-0392-0562-0524-Typ01

Drawer set type 01, features: 3 drawers, 1 stationery drawer, with lock
Surface: Price group LC, Le Corbusier

W 39,2 | D 56,2 | H 52,4 cm MSCT-0392-0562-0524-Typ01



A WORLD OF COLOURS AND MATERIALS

Das Bosse Einrichtungssystem modul space lebt von seiner Flexibilität und Anpassungsfähigkeit. Das gilt auch für die Materialauswahl. Für die nahezu grenzenlose Individualisierbarkeit stehen zahlreiche Dekore und Oberflächen zur Auswahl: Ob unempfindliches Melamin oder Melamindekor, edle Naturholzoberflächen oder verschiedene Glasqualitäten – Ihre persönliche Gestaltungsidee setzt die Maßstäbe.

The Bosse modul space furniture system thrives on its flexibility and adaptability. The same applies to the choice of materials too. For virtually unlimited customisation options, numerous finishes and surfaces are available. From hardwearing melamine or melamine finishes to elegant natural wood surfaces or various types of glass, your personal design idea sets the standards.

RAL FARBEN | RAL COLOURS









Alle RAL Farben ohne Metallic oder Leuchtfarben (Preisgruppe E). Einsatz von weiteren Farbsystemen gegen Aufpreis von 250,00 € zzgl. MwSt. pro Kommission und Farbe möglich. Die Darstellung des RAL CLASSIC Farbfächers erfolgt mit Genehmigung der RAL GmbH, Sankt Augustin. Die Bezeichnung RAL ist markenrechtlich geschützt. www.ral-farben.de

All RAL colours (price group E) without metallic or luminous paint. Other colour systems can be used for a surcharge of 250,00 € + VAT per commission and colour. The RAL CLASSIC colour fan is used with permission of RAL GmbH, Sankt Augustin. RAL is a registered trademark. www.ral-farben.com

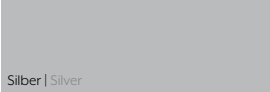



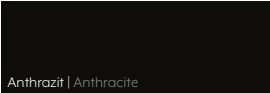

GLAS | GLASS



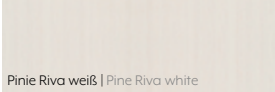

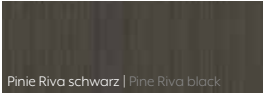

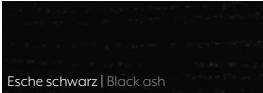

UNIDEKORE | UNI FINISH

 Weiß White	 Silber Silver
 Crème winterweiß Creme winter white	 Vulkangrau Volcano grey
 Congo Congo	 Anthrazit Anthracite
 Grau Grey	 Vulkanschwarz VV Volcano black VV

HOLZDEKOR | WOOD FINISH

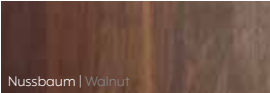
 Pinie Riva weiß Pine Riva white	 Pompeji dunkel Pompeji dark
 Ahorn Maple	 Pinie Riva schwarz Pine Riva black
 Eiche hell Light oak	 Esche schwarz Black ash
 Pinie Navara Navara pine	 Nussbaum Walnut

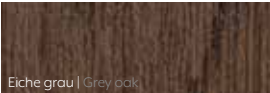
ECHTHOLZ | REAL WOOD

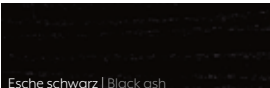
 Buche natur Natural beech	 Kirsche Cherry
 Ahorn natur Natural maple	 Nussbaum Walnut
 Eiche hell Light oak	 Eiche grau Grey oak
 Erle natur Natural ash	 Esche schwarz Black ash

LE CORBUSIER

 ▶ 4320B blancivoire (0750 LC)	 ▶ 32142 ombre naturelle claire (0751 LC)
 ▶ 4320W le jaune vif (0760 LC)	 ▶ 32013 gris clair 31 (0752 LC)
 ▶ 32053 vert jaune clair (0761 LC)	 ▶ 32011 gris 31 (0753 LC)
 ▶ 32021 outremer moyen (0755 LC)	 ▶ 32010 gris foncé 31 (0754 LC)
 ▶ 4320K bleu outremer 59 (0756 LC)	 ▶ 4320A rouge vermillon 59 (0758 LC)
 ▶ 4320T bleu outremer foncé (0757 LC)	 ▶ 32090 rouge vermillon 31 (0759 LC)

Les Couleurs® Le Corbusier ist ausschließlich für Deutschland, Österreich und die Schweiz lizenziert. Bei Interesse außerhalb der D-A-CH Region bitte separat anfragen.
Les Couleurs® Le Corbusier is licensed exclusively for Germany, Austria and Switzerland. If you are outside the D-A-CH region please ask for it separately.

MODUL SPACE SYSTEM

Das Baukastensystem Bosse modul space besticht durch seine nahezu unbegrenzte Modularität. Die hochwertigen Rohre, Knoten und Paneele bilden die Basis eines Systems, mit dem sich unterschiedlichste Möbel- und Einrichtungslösungen realisieren lassen. Um die Planung zu vereinfachen, stehen Türen, Schübe und Klappen in vorgegebenen Rastermaßen zur Verfügung. Die exakten Werte sind in der Grafik aufgeführt.

The Bosse modul space building-block-system impresses with its almost unlimited modularity. The high-quality tubes, connectors and panels form the basis of a system that can be used to create a wide range of different furniture and furnishing solutions. To simplify the planning process, swing doors, drawers and drop doors are available in specified modular dimensions. The exact sizes are shown in the graphic.

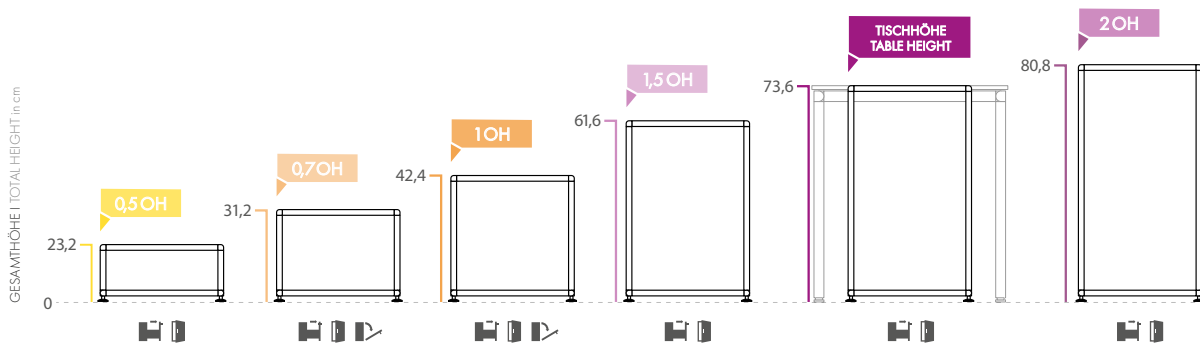

RASTER GRID

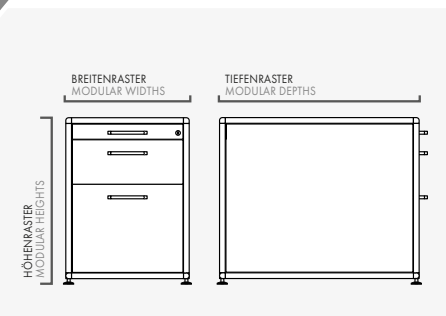

MAßE MEASUREMENTS

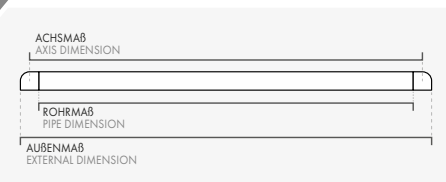

GESAMTROHRLÄNGE FÜR OFFENE ELEMENTE ENTIRE TUBE LENGTH FOR OPEN ELEMENTS

ROHRMAß PIPE DIMENSIONS	ACHSMAß AXIS DIMENSIONS	AUßENMAß EXTERNAL DIMENSIONS
12,0		
15,0	14,0	16,0
17,2	17,0	19,0
25,2	19,2	21,2
36,4	27,2	29,2
39,2	38,4	40,4
46,2	41,2	43,2
52,4	48,2	50,2
55,6	54,4	56,4
56,2	57,6	59,6
67,6	58,2	60,2
74,8	69,6	71,6
76,2	76,8	78,8
94,0	78,2	80,2
96,2	94,0	98,0
113,2	96,2	100,2
116,2	113,2	117,2
	116,2	120,2

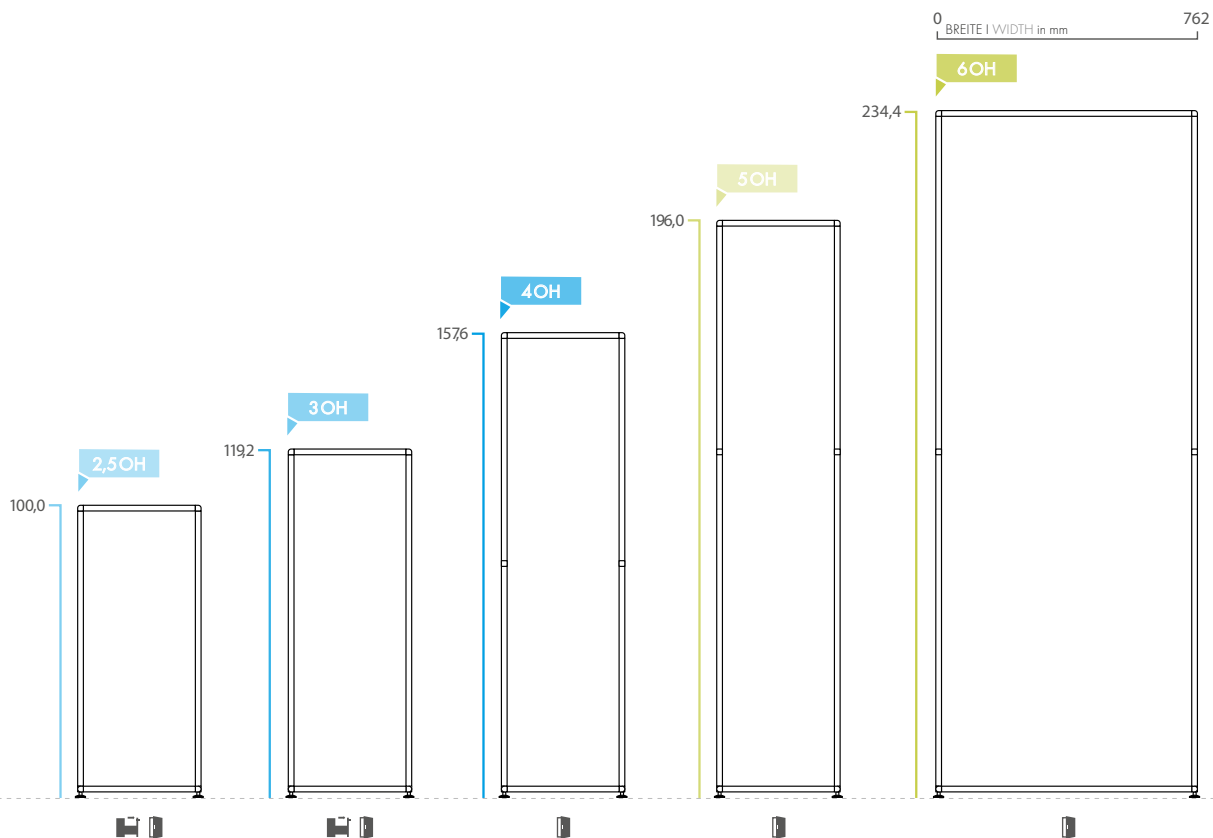

BREITENRASTER
MODULAR WIDTHS

KNOTEN (2 CM) + ROHR + KNOTEN (2 CM)
CONNECTOR (2 CM) + TUBE + CONNECTOR (2 CM)

2 39,2 2

2 46,2 2

2 56,2 2

2 76,2 2

2 96,2 2

2 116,2 2

HÖHENRASTER
MODULAR HEIGHTS

FÜßE (2 CM) + KNOTEN (2 CM) + ROHR + KNOTEN (2 CM)
FEET (2 CM) + CONNECTOR (2 CM) + TUBE + CONNECTOR (2 CM)

2 17,2 2+2

2 25,2 2+2

2 36,4 2+2

2 55,6 2+2

2 67,2 2+2

2 74,8 2+2

2 94,0 2+2

2 113,2 2+2

TIEFENRASTER
MODULAR DEPTHS

KNOTEN (2 CM) + ROHR + KNOTEN (2 CM)
CONNECTOR (2 CM) + TUBE + CONNECTOR (2 CM)

2 25,2 2

2 39,2 2

2 46,2 2

2 56,2 2



REFERENCES

Bosse ist weltweit erfolgreich im Einsatz. In unterschiedlichsten Unternehmen, Branchen und Architekturen. Elegant, funktional und perfekt auf jede einzelne Anforderung zugeschnitten. Viele weitere Referenzen finden Sie online auf dauphin-group.com/referenzen.

Bosse operates successfully worldwide. In a variety of different companies, sectors and architectures. Elegant, functional and perfectly tailored to suit every single requirement. You can find lots of other references online at dauphin-group.com/en/references.

T.CON GMBH & CO. KG



LEICA CAMERA AG



TU MÜNCHEN



COURT OF JUSTICE OF THE EUROPEAN UNION



WORTMANN KG
INTERNATIONAL SHOE PRODUCTION



SAMSUNG ELECTRONICS GMBH



BAVARIA FILMSTUDIOS



MEBA



ZUMTOBEL LED DIVISION



KRONES AG



HOSPITAL BARMHERZIGE BRÜDER



CEG CHINA EAGLE GROUP



INTERFRACHT SPEDITIONS AG



IMPLENIA INDUSTRIAL





bosse.de
dauphin-group.com

Hersteller | Manufacturer:
Bosse Design Gesellschaft für
Innovative Office Interiors mbH & Co. KG
Stahler Ufer 7
37671 Hörter/Stahle, Germany
+49 5531 1297-0
info@bosse.de

Vertrieb | Distribution:
Dauphin HumanDesign® Group GmbH & Co. KG
Espanstraße 36
91238 Offenhausen, Germany
+49 9158 17-700
info@dauphin-group.com

Bosse